

# Baby's Smash Cake

Only available with additional purchase

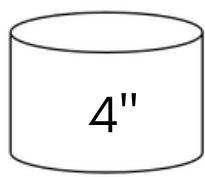

4"

\$15

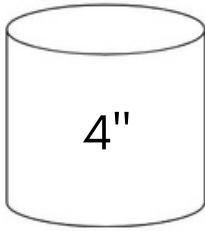

4"

3 layers

4-8 servings

\$20-25

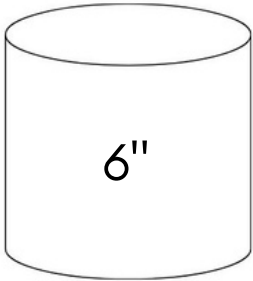

6"

3 or 4 layers

14-20 servings

\$50-70

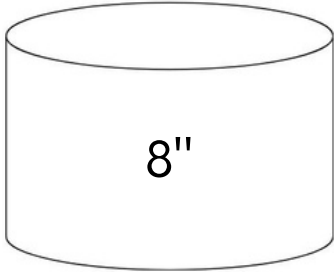

8"

3 or 4 layers

30-40 servings

\$70-90

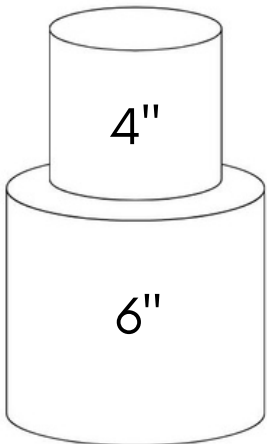

4"

3 layers each tier

20-26 servings

\$90-115

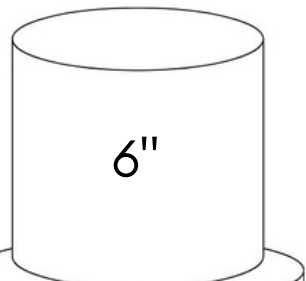

6"

3 layers each tier

44-52 servings

\$140-170

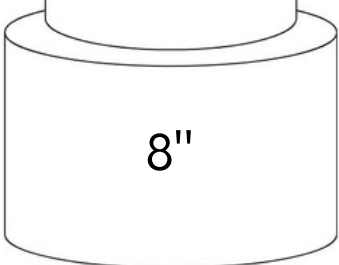

8"

# Flavors

Almond Berry

Blackberry Lemon Poppy

Carrot Cake

Coconut Creme

Lemon Raspberry

Spiked Apple

Strawberry Lemonade

Strawberries N Cream

Black and White

Bourbon Salted Caramel Choc Stout

Chocolate Covered Strawberry

Choc Peanut Butter

Cookies N Cream

Mint Choc Chip

\*Number of servings is dependent on how the cake is cut + number of layers

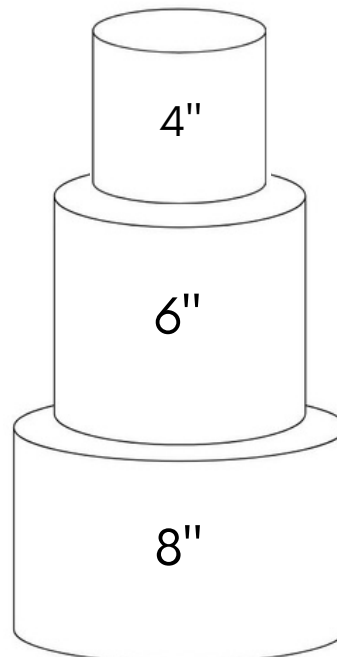

4"

6"

8"

3 layers each tier

60 servings

\$230-260